

FLEXIDOME panoramic 5100i IR



- ▶ 360° panoramic overview in 6MP and 12MP resolution without blind spots
- ▶ Optimized for all lighting conditions with integrated IR and High Dynamic Range
- ▶ Edge or client-side dewarping for easy integration and flexible viewing and recording
- ▶ Built-in Intelligent Video Analytics and Audio AI to trigger relevant alerts and quickly retrieve data
- ▶ Compact design protected against vandalism and all weather conditions

The FLEXIDOME panoramic 5100i IR is a vandal resistant discreet, aesthetic, panoramic camera for indoor and outdoor surveillance without blind spots. With its stereographic panoramic lens, it provides full 360° coverage and complete area overview with improved details. The camera offers full situational awareness, and simultaneous high-resolution zoomed-in images. The high-end system on chip (SoC) provides flexible dewarping possibilities and reliable Intelligent Video Analytics and Audio AI. With its integrated IR and wide range of connections, it can be used in any application, both day and night. The camera has an IK10 and IP66 design to protect itself against vandalism and all weather conditions.

Functions

Up to 12MP sensor resolution

The camera offers a choice between a 6MP or 12MP sensor to optimize for the amount of details required. Both options offer 30 fps to ensure real-time motion in your scenes. Together with its stereographic lens the image circle offers a 4.5MP and 9MP effective resolution.



360°

Panoramic vision and Intelligent Video Analytics

Combining the latest generation of the Bosch Intelligent Video Analytics software with full panoramic vision, produces an extremely powerful surveillance tool, which enriches full situational awareness. With intelligent tracking, movement can be followed continuously throughout the full image circle. There is no need to hand off tracking from one camera to another, greatly simplifying movement analysis. The system reliably detects, tracks, and analyzes objects, and alerts you when predefined alarms are triggered. A smart set of alarm rules makes complex tasks easy and reduces false alarms to a minimum. Specifically designed for the most demanding environments. It is extremely resistant to false triggers caused by challenging environments with snow, wind (moving trees), rain, hail, and water reflections.

Calibration is quick and easy - just enter the height of the camera. The internal gyro/accelerometer sensor provides the rest of the information to precisely calibrate the video analytics.

Camera Trainer

Based on examples of target objects and non-target objects, the new Camera Trainer program uses machine learning to allow the user to define objects of interest and generate detectors for them. In contrast to the moving objects that the Intelligent Video Analytics application detects, the Camera Trainer program detects both moving and non-moving objects and classifies them immediately. Using Configuration Manager, you can configure the Camera Trainer program using both live video as well as recordings available through the respective camera. The resulting detectors can be downloaded and uploaded for distribution to other cameras.

A free of charge license is required to activate the Camera Trainer program.

Audio AI

The camera has an integrated microphone array with three digital microphones for audio analytics and Audio AI. It offers an alarm functionality for events such as glass breaking, gunshot detection, screaming, or other loud noises. The camera is not only able to classify sounds, but also to provide an approximate location of the sound. There is no need to record audio, as it is possible to examine sound characteristics only.

If required by local laws, the microphone can be permanently blocked via a secure license key.

Dewarping

The lens captures a circular image. Our dewarping software transforms this circular image into several different distortion-free rectangular views. To facilitate system integration, you can choose edge dewarping inside the camera or client-side dewarping on an external platform.

The edge dewarping in the camera provides three separate video channels simultaneously:

- Full image circle (Video 1 channel)
- Dewarped view mode (Video 2 channel)
- E-PTZ (Video 3 channel)

Different view modes can be selected for the video 2 channel. Your selection depends on the resolution you require and how you wish to view the dewarped image.

View modes

The following view modes can be select in the camera or on the client:

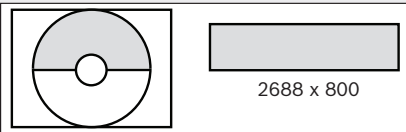
	Full image cut-out and displayed image
Panoramic view (ceiling mount)	 <p>2688 x 800</p>

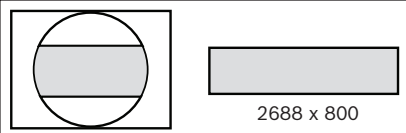
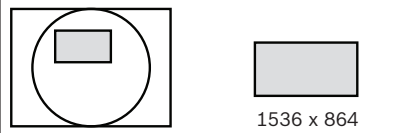
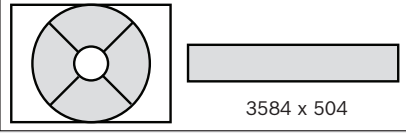
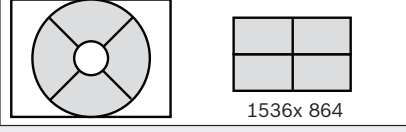
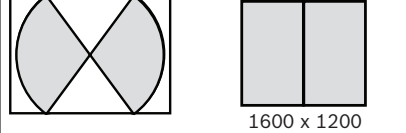
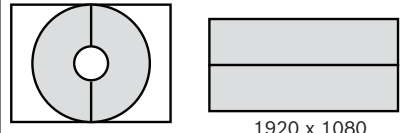
	Full image cut-out and displayed image
Panoramic view (wall mount)	 <p>2688 x 800</p>
E-PTZ view	 <p>1536 x 864</p>
Full panoramic view	 <p>3584 x 504</p>
Quad view	 <p>1536x 864</p>
Corridor view	 <p>1600 x 1200</p>
Double panoramic view	 <p>1920 x 1080</p>

HDMI output

The camera has a micro-HMDI output for local viewing or for connection to a confrontation monitor; ideal for retail usage. It offers 1080p resolution and the flexibility to display both warped and dewarped images.

High Dynamic Range

The camera has High Dynamic Range. This is based on a multiple-exposure process that captures more details in the highlights and in the shadows even in the same scene. The result is that you can easily distinguish objects and features, for example, faces with bright backlight.

The actual dynamic range of the camera is measured using Opto-Electronic Conversion Function (OECF) analysis according to IEC 62676 Part 5. This method is used to provide a standard result which can be used to compare different cameras.

DORI coverage

DORI (Detect, Observe, Recognize, Identify) is a standard system (EN-62676-4) for defining the ability of a person viewing the video to distinguish persons or objects within a covered area. The maximum distance at which a camera/lens combination can meet these criteria is shown below:

When mounted at a height of 3 m (10 ft) the 360° version of the camera has the following coverage radius for the four levels:

DORI	DORI definition	Coverage radius
Detect	25 px/m (8 px/ft)	TBD
Observe	63 px/m (19 px/ft)	TBD
Recognize	125 px/m (38 px/ft)	TBD
Identify	250 px/m (76 px/ft)	TBD

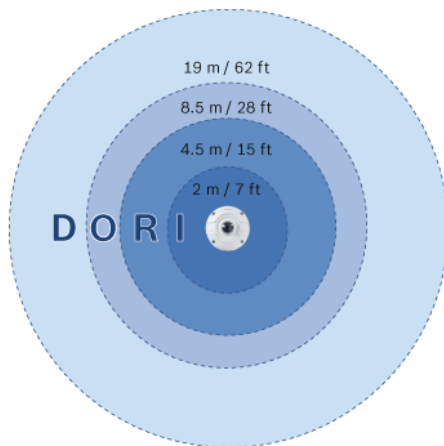

E-PTZ and regions of interest

The remote E-PTZ (Electronic Pan, Tilt and Zoom) controls allow you to select specific areas of the full image circle. These Regions of Interest (ROI) can be easily defined, allowing the most interesting part of a scene to be monitored separately. The high resolution ensures that details are not lost even when using the electronic zoom.

The E-PTZ feature of a panoramic camera has some advantages over normal PTZ cameras. There is no camera movement so the camera does not draw attention to itself or appear intrusive. Situational awareness is still retained even when zooming in on a particular object of interest. The smooth E-PTZ function helps navigation, and presets are available for setting up a guard tour.

Record exactly what you want

The camera provides the full resolution circular image for recording even if you are viewing only a portion of the scene. This means that you can always perform retrospective dewarping and analyses on the complete area covered and then zoom in on the region or object of interest.

With edge-dewarping you can also choose to only record the relevant parts of the scene which helps reduce bitrates significantly.

Intelligent streaming

Smart encoding capabilities, together with Intelligent Dynamic Noise Reduction technology and analytics, make the bandwidth consumption drop to extremely low levels. Only relevant information in the scene, such as motion or objects found with the analytics, are encoded.

Each of these streams can be adapted independently to deliver high quality video, perfectly tailored to purpose, while reducing bit rate by up to 90% compared to a standard camera.

Priority exposure control

To optimize image quality, eight zones for measuring the exposure can be drawn on the full image circle and assigned a priority level. These zones are given a higher or lower priority when the camera calculates the exposure level. This ensures that the important areas of the scene have the ideal exposure level.

Intelligent Auto Exposure

Fluctuations in backlight and front light can ruin your images. To achieve the perfect picture in every situation, Intelligent Auto Exposure automatically adjusts the exposure of the camera. It offers superb front light compensation and incredible backlight compensation by automatically adapting to changing light conditions.

Scene modes

The camera has a very intuitive user interface that allows fast and easy configuration. Multiple preset configurable modes are provided with the best settings for a variety of applications. Different scene modes can be selected for different situations, such as sodium lighting or dark environments.

Edge recording

Insert a memory card into the card slot to store up to 2 TB of local alarm recording. Pre-alarm recording in RAM reduces recording bandwidth on the network, and extends the effective life of the memory card. It has advanced edge recording providing a reliable storage solution possible due to the combination of these functions:

- Industrial SD card support allows for extreme lifetime
- Health monitoring of industrial SD cards provide early service indications.

Data security

Special measures have been put in place to ensure the highest level of security for device access and data transport. The three-level password protection with security recommendations allows users to customize device access. Web browser access can be protected using HTTPS and firmware updates can also be protected with authenticated secure uploads. The cameras have built-in Secure Element (SE) hardware providing main Trusted Platform Module (TPM) functionality to ensure the highest levels of data security and privacy protection. Together with Public Key Infrastructure (PKI) support, superior protection from malicious attacks is guaranteed. The 802.1x network authentication with EAP/TLS, supports TLS 1.2 with updated cipher suites including AES 256 encryption. The advanced certificate handling offers:

- Self-signed unique certificates automatically created when required
- Client and server certificates for authentication
- Client certificates for proof of authenticity
- Certificates with encrypted private keys

Modular accessories

A full line of modular accessories is available that allows a consistent design across different cameras and a wide range of installation possibilities. Available options include wall or pipe mount, a surveillance cabinet with power and fiber optic options, and an in-ceiling mounting kit. There is also a conduit adapter available for installations on concrete walls or ceilings.

H.265 high-efficiency video encoding

The camera is designed on the most efficient and powerful H.264 and H.265/HEVC encoding platform. The camera is capable of delivering high-quality and high-resolution video with very low network load. With a doubling of encoding efficiency, H.265 is the new compression standard of choice for IP video surveillance systems.

System integration and ONVIF conformance

The camera conforms to the ONVIF Profile S, ONVIF Profile G and ONVIF Profile T specifications. For H.265 configuration, the camera supports Media Service 2, which is part of ONVIF Profile T. Compliance with these standards guarantees interoperability between network video products regardless of manufacturer. Third-party integrators can easily access the internal feature set of the camera for integration into large projects. Visit the Bosch Integration Partner Program (IPP) website (ipp.boschsecurity.com) for more information.

Cloud-based services

The camera supports time-based or alarm-based JPEG posting to four different accounts. These accounts can address FTP servers or cloud-based storage facilities (for example, Dropbox). Video clips or JPEG images can also be exported to these accounts.

Alarms can be set up to trigger an e-mail or SMS notification so you are always aware of abnormal events.

Bosch Remote Portal

With the secure cloud infrastructure, Bosch Remote Portal, you can manage your connected Bosch devices. From the Bosch Remote Portal you can:

- Complete initial configuration of your connected Bosch devices (online or offline).
- Update firmware for single or multiple devices.
- Manage certificates.
- Monitor the health of your connected Bosch devices.

Two-way audio and built-in microphone

Two-way audio allows the operator to communicate with visitors or intruders via an external audio line input and output. Alternatively, there is an integrated microphone to capture crisp and clear audio. By using the integrated or external microphone, audio detection can be used to generate alarms to alert the security operator quicker and act more proactively. If required by local laws, the microphone can be blocked via a secure license key.

Resists rain, dust, and tampering with reliable operation across a wide temperature range

Suitable for indoor and outdoor usage.

The robust design of the camera is rated to IP66 and IK10 standards, safeguarding the camera against rain and dust while also offering protection against vandalism and tampering.

The camera can operate in a wide ambient temperature range between -40 °C up to +55 °C / -40 °F up to 131 °F.

Certifications and approvals

Standards	Type
Emission	EN 50121-4: 2016; EN55032: 2015, AC: 2016; CFR 47 FCC part 15 : 2012-10-1, Class B
Environmental	EN 50581 (2012)
Environmental Tests	EN 50130-4: 2011, A1: 2014
Immunity	EN 50121-4: 2016; EN 50130-4: 2011, A1: 2014
Marks	CE, FCC, UL, WEEE, RCM, VCCI, EAC, BIS, KCC, CMIM, UKCA, China RoHS
Safety	EN 60950-1: 2006, A11: 2009, A1: 2010, A12: 2011, A2: 2013; UL 60950-1, 2nd edition; CAN/CSA-C 22.2 No. 60950-1-07, 2nd edition;

Standards	Type
	EN 60950-22: 2006, A11: 2008; UL 60950-22, 1st edition; CSA C22.2 NO. 60950-22-07 Edition 1
Image performance	IEC 62676-5
Impact protection	EN 62262 (IK10)
Ingress protection	EN 60529 (IP67) and NEMA 4X
IR lighting	IEC 62471

Installation/configuration notes

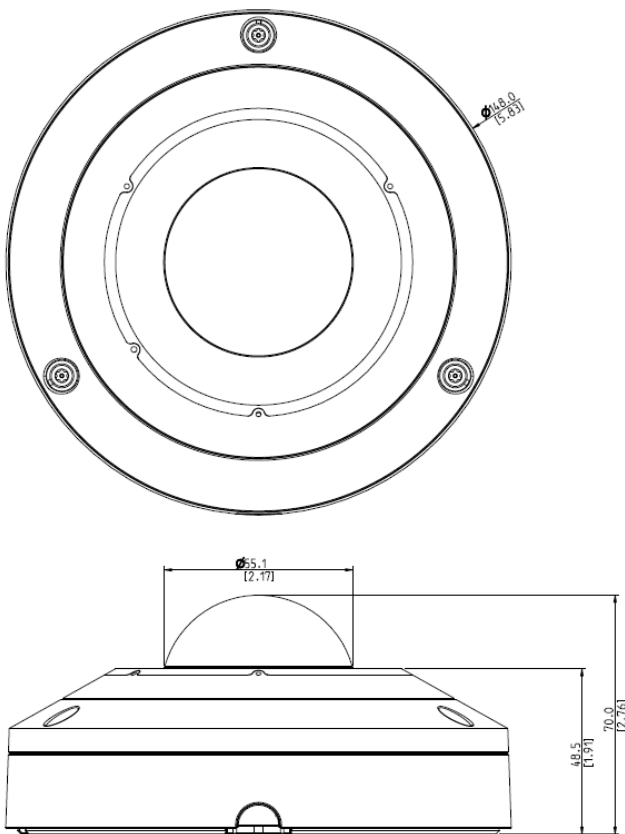

All dimensions in the drawings are in mm (inch).

Technical specifications

Power	
Power supply	+12 VDC \pm 5%, 24 VAC \pm 10% or Power-over-Ethernet (48 VDC nominal)
Power consumption (DC)	12 W max.
Power consumption (AC)	24 W max.
Power consumption (PoE)	TBD W max.

Power	
PoE	IEEE 802.3af (802.3at Type 1)
Sensor	
Total sensor pixels	6 MP
Type (6 MP)	1/1.8-inch CMOS
Used pixels (6 MP)	2110 x 2110 (4.5 MP)
Total sensor pixels	12 MP
Type (12 MP)	1/2.3-inch CMOS
Used pixels (12 MP)	3000 x 3000 (9 MP)

Video performance - Sensitivity

Measured according to IEC 62676 Part 5 (1/25, F1.2)

Color (6 MP)	TBD lx
Mono (6 MP)	TBD lx
With IR (6 MP)	TBD lx
Color (12 MP)	TBD lx
Mono (12 MP)	TBD lx
With IR (12 MP)	TBD lx

Video performance - Dynamic range

Dynamic range	120 dB WDR
Measured according to IEC 62676 Part 5	TBD dB WDR (6 MP) TBD dB WDR (12 MP)

Video streaming

Video compression	H.265/HEVC; H.264 (MP); M-JPEG
Streaming	Multiple configurable streams in H.265, H.264 and M-JPEG, configurable frame rate and bandwidth. Multiple channels with edge dewarping. Regions of Interest (ROI)
Overall IP Delay	Min. 120 ms, Max. 340 ms
GOP structure	IP, IBP, IBBP
Frame rate	1-30fps
Encoder regions	Eight independent areas for setting encoder quality to optimize bitrate.

Video resolution (H x V)		
Video 1 channel	Full image circle	2110 x 2110 (6 MP) 3000 x 3000 (12 MP)
Video 2 channel	Full panoramic	TBD
	E-PTZ	TBD
	Quad	TBD
	Panoramic	TBD
	Double panoramic	TBD
	Corridor	TBD
Video 3 channel	E-PTZ	TBD
Video functions		
Day/Night	Color, Monochrome, Auto (adjustable switchover points)	
Adjustable picture settings	Contrast, Saturation level and control, Brightness, Sharpness	
White Balance	2500 to 10000K, 4 automatic modes (Basic, Standard, Sodium vapor, Dominant color), Manual mode and Hold mode	
Shutter	Automatic Electronic Shutter (AES) Fixed (1/30 [1/25] to 1/15000) selectable Default shutter	
Backlight compensation	Off / On / Intelligent Auto Exposure (BLC)	
Noise reduction	Intelligent Dynamic Noise Reduction Intelligent Streaming	
Intelligent defog	Intelligent defog automatically adjusts parameters for best picture in foggy or misty scenes	
Exposure region	Multiple selectable regions	
Privacy Masking	Eight independent areas, fully programmable	
Scene modes	Multiple default modes with scheduler	
Pre-positions	Six independent sectors	
Display stamping	Individual names and stamps for all video channels	
Other functions	Pixel counter, Video watermarking, Location	

Video content analysis	
Analysis type	Intelligent Video Analytics, Camera Trainer
Alarm rules (combinable)	Any object, Object in field, Line crossing, Enter / leave field, Loitering, Follow route, Idle / removed object, Counting, Occupancy, Crowd density estimation, Condition change, Similarity search, Flow / counter flow
Object filters	Duration, Size, Aspect ratio, Speed, Direction, Color, Object classes (4)
Tracking modes	Standard (2D) tracking, 3D tracking, 3D people tracking, Ship tracking, Museum mode
Calibration / Geolocation	Automatic, based on gyro sensor, focal length and camera height
Audio AI	Gunshot detection, glass-break detection, loud noises detection, TBD
Night vision	
Distance	30 m (98 ft)
LED	360° LED high efficiency array, 850 nm
IR intensity	Adjustable
Optical	
Lens	1.2 mm fixed-focus lens F2.0 (6 MP) 1.27 mm fixed-focus lens F.2.0 (12 MP)
Lens mount	Board mounted
Iris control	Fixed iris
Day/Night	Switchable IR-cut filter
Field of view	182° (H) x 182° (V)
Minimum object distance	0.1 m
Local storage	
Internal RAM	5 s pre-alarm recording
Memory card slot	Micro SDXC / SDHC / SD card
Industrial SD cards	Extreme lifetime and health monitoring support (if supported by the SD card) that provides early service indication.
Input/output	
Audio line in	0.707 Vrms max, 10 kOhm typical

Input/output	
Audio line out	0.707 Vrms at 16 Ohm typical
Audio input	Two-way audio and built-in microphone
Alarm input	1 input
Alarm input activation	Short or DC 5V activation
Alarm output	1 output
Alarm output voltage	30 VDC, max. load 0.5 A
HDMI output	Micro HDMI connector and 1080p resolution with dewarped viewing possibilities
Microphone	Integrated microphone array with 3 three digital MEMS microphones
Ethernet	RJ-45
Fiber optics (sold separately)	The Fiber Optic Ethernet Media Converter kit (VG4-SFPSCKT) installed inside a Surveillance Cabinet (NDA-U-PA0, NDA-U-PA1 or NDA-U-PA2) provides the fiber optic interface to the mounted camera.

Audio streaming	
Standard	G.711, 8 kHz sampling rate L16, 16 kHz sampling rate AAC-LC, 96 kbps at 32/48 kHz sampling rate
Signal-to-Noise Ratio	>50 dB
Audio Streaming	Full-duplex / half duplex

Platform	
Common product platform	CPP14

Data security	
Secure Element	RSA 4096 bit, AES/CBC 256 bit
PKI	X.509 certificates
Encryption	Full end-to-end encryption with supported VMS Network: TLS1.0/1.1/1.2, AES128, AES256 Local storage: XTS-AES
Video authentication	checksum, MD5, SHA-1, SHA-256

Network	
Protocols	IPv4, IPv6, UDP, TCP, HTTP, HTTPS, RTP/RTCP, IGMP V2/V3, ICMP, ICMPv6, RTSP, FTP, ARP, DHCP, APIPA (Auto-IP, link local address), NTP (SNTP), SNMP (V1, V3, MIB-II), 802.1x, DNS, DNSv6, DDNS (DynDNS.org, selfHOST.de, no-ip.com), SMTP, iSCSI, UPnP (SSDP), DiffServ (QoS), LLDP, SOAP, Dropbox™, CHAP, digest authentication
Encryption	TLS1.0/1.1/1.2, AES128, AES256
Ethernet	10/100/1000 Base-T, auto-sensing, half/full duplex
Connectivity	Auto-MDIX
Interoperability	ONVIF Profile S; ONVIF Profile G; ONVIF Profile T

Mechanical	
Dimensions (Ø x H)	148 x 65 mm (5.82 x 2.55 in)
Lens adjustment (rotation)	360°
Weight	TBD
Color	White (RAL9003)
Gyrosensor	Yes
Dome bubble	Polycarbonate, clear with UV blocking anti-scratch coating
Housing	Aluminum with dehumidifying membrane and waterproof connection area
Mounting	Mounting plate included for surface mount, 4-inch square junction box, single and double gang box
Conduit	Compatible with conduit back box for 3/4-inch NPT (M25) conduit side entry (sold separately)

Environmental	
Operating temperature	-40°C to +55°C (-40°F to 131°F)
Storage temperature	-TBD°C to +TBD°C (-TBD°F to TBD°F)
Operating humidity	5% to 93% RH non-condensing 5% to 100% RH condensing
Storage humidity	Up to 98% RH
Impact protection	IK10
Ingress protection	IP66 and NEMA Type 4X

Environmental

Sustainability PVC free

Ordering information**NDS-5703-F360LE Fixed dome 6MP 360° IR IP66**

360° 6MP panoramic camera with HDR, IVA, microphone array for Audio AI, HDMI, H.265, vandal and weather protection

Order number **NDS-5703-F360LE | F.01U.385.630**

NDS-5704-F360LE Fixed dome 12MP 360° IR IP66

360° 12MP panoramic camera with HDR, IVA, microphone array for Audio AI, HDMI, H.265, vandal and weather protection

Order number **NDS-5704-F360LE | F.01U.385.631**

Accessories**NDA-5080-PIP Pendant Interface Plate**

Pendant interface plate for FLEXIDOME panoramic 5100i and FLEXIDOME panoramic 5100i IR

Order number **NDA-5080-PIP | F.01U.389.607**

NDA-U-WMT Pendant wall mount

Universal wall mount for dome cameras, white

Order number **NDA-U-WMT | F.01U.324.939**

NDA-U-WMP Wall mount plate

Back plate for universal wall mount, corner mount and pole mount, white, IP66

Order number **NDA-U-WMP | F.01U.324.950**

NDA-U-PMT Pendant pipe mount, 12" (31cm)

Universal pipe mount for dome cameras, 31 cm, white

Order number **NDA-U-PMT | F.01U.324.940**

NDA-U-PMTE Pendant pipe extension, 20" (50cm)

Extension for universal pipe mount, 50 cm, white

Order number **NDA-U-PMTE | F.01U.324.941**

NDA-U-PMTS Pendant pipe mount, 4" (11 cm)

Universal pendant pipe mount for dome cameras, 11 cm (4"), white

Order number **NDA-U-PMTS | F.01U.385.046**

NDA-U-PSMB Pendant wall/ceiling mount SMB

Surface mount box (SMB) for wall mount or pipe mount.

Order number **NDA-U-PSMB | F.01U.324.942**

NDA-U-PMAS Pole mount adapter small

Pole mount adapter small

Universal pole mount adapter, white; small.

Order number **NDA-U-PMAS | F.01U.324.943**

NDA-U-PMAL Pole mount adapter large

Universal pole mount adapter, white; large

Order number **NDA-U-PMAL | F.01U.324.944**

NDA-5080-TM Tilt mount 20-deg, 148mm

Tilt mount (20°) for FLEXIDOME IP starlight 5000i (IR) - indoor/outdoor and FLEXIDOME panoramic 5100i camera families

Order number **NDA-5080-TM | F.01U.389.606**

NDA-U-CMT Corner mount adapter

Universal corner mount, white

Order number **NDA-U-CMT | F.01U.324.946**

NDA-U-PMTG Pendant pipe mount, gang box

Universal pipe mount, compatible with gang box installation for fixed dome cameras only, white

Order number **NDA-U-PMTG | F.01U.358.359**

NDA-U-WMTG Pendant wall mount, gang box

Universal wall mount, compatible with gang box installation for fixed dome cameras only, white

Order number **NDA-U-WMTG | F.01U.358.358**

NPD-3001-WAP Portable installation tool

Bosch camera portable and wireless installation tool

Order number **NPD-3001-WAP | F.01U.353.329**

NPD-5001-POE Midspan, 15W, single port, AC in

Power-over-Ethernet midspan injector for use with PoE enabled cameras; 15.4 W, 1-port

Weight: 200 g (0.44 lb)

Order number **NPD-5001-POE | F.01U.305.288**

NPD-5004-POE Midspan, 4 port x 15W, AC in

Power-over-Ethernet midspan injector for use with PoE enabled cameras; 15.4 W, 4-ports

Weight: 620 g (1.4 lb)

Order number **NPD-5004-POE | F.01U.305.289**

VG4-SFPSCKT ETHERNET TO SFP INTERFACE KIT

Ethernet media converter video transmitter/data receiver fiber optic kit for AUTODOME cameras, for MIC-IP-PSU for MIC analog cameras and for the Surveillance cabinets (NDA-U-PA0, NDA-U-PA1 and NDA-U-PA2).

Order number **VG4-SFPSCKT | F.01U.142.529**

SFP-2 Fiber module, multimode, 1310nm, 2LC

SFP Fiber Optic Module, 2 km (1.2 miles), 2 LC connectors.

Multi-mode

1310 nm

Order number **SFP-2 | F.01U.136.537**

SFP-3 Fiber module, single-mode, 1310nm, 2LC

SFP Fiber Optic Module, 20 km (12.4 miles), 2 LC connectors.

Single-mode

1310 nm

Order number **SFP-3 | F.01U.136.538**

SFP-25 Fiber module, 1310/1550nm, 1SC

SFP Fiber Optic Module, 2 km (1.2 miles), 1 SC connector

Multi-mode

1310/1550 nm

Order number **SFP-25 | F.01U.136.541**

SFP-26 Fiber module, 1550/1310nm, 1SC

SFP Fiber Optic Module, 2 km (1.2 miles), 1 SC connector

Multi-mode

1550/1310 nm

Order number **SFP-26 | F.01U.136.542**

Represented by:

Europe, Middle East, Africa:

Bosch Security Systems B.V.
P.O. Box 80002
5600 JB Eindhoven, The Netherlands
Phone: + 31 40 2577 284
emea.securitysystems@bosch.com
emea.boschsecurity.com

Germany:

Bosch Sicherheitssysteme GmbH
Robert-Bosch-Ring 5
85630 Grasbrunn
Germany
www.boschsecurity.com

North America:

Bosch Security Systems, LLC
130 Perinton Parkway
Fairport, New York, 14450, USA
Phone: +1 800 289 0096
Fax: +1 585 223 9180
onlinehelp@us.bosch.com
www.boschsecurity.us

Asia-Pacific:

Robert Bosch (SEA) Pte Ltd, Security Systems
11 Bishan Street 21
Singapore 573943
Phone: +65 6571 2808
Fax: +65 6571 2699
apr.securitysystems@bosch.com
www.boschsecurity.asia