



Bosch Security Systems B.V.

Torenallee 49
5617 BA Eindhoven
The Netherlands

www.boschsecurity.com

© Bosch Security Systems B.V., 2014

DINION IP 8000 MP

NBN-80052 / NBN-80122



BOSCH

en Installation Manual

Table of contents

1	Safety	5
1.1	Safety message explanation	5
1.2	Safety precautions	5
1.3	Important safety instructions	6
1.4	FCC and ICES compliance	7
1.5	Notices	8
2	Short information	9
2.1	Copyrights	9
3	System overview	10
3.1	Application variants	10
3.2	Using the camera	10
3.3	Operation with external systems	11
4	Planning information	12
4.1	Unpacking	12
4.2	System requirements	12
5	Installation	13
5.1	Lens mounting	13
5.2	Mounting the camera	15
5.3	Local storage	16
6	Connection	17
6.1	Network (and PoE power) connector	17
6.2	Auxiliary power connector	19
6.3	Alarm input and output connector	20
6.4	Audio connectors	22
6.5	Video monitor connector	23
6.6	Data connector	24
7	Configuration	25
7.1	Setting the field of view	25
7.1.1	Camera install wizard	25
7.1.2	Using the install wizard	26
7.2	True Day/Night switching	29
7.3	Camera configuration	30
7.4	Browser connection	30

7.4.1	Establishing the connection	30
7.4.2	Protected network	30
8	Troubleshooting	31
8.1	Function test	31
8.2	Resolving problems	31
8.3	Testing the network connection	35
8.4	Customer service	35
8.5	Terminal program	36
9	Maintenance	38
9.1	Cleaning	38
9.2	Reset	38
9.3	Repair	38
10	Decommissioning	39
10.1	Transfer	39
10.2	Disposal	39
11	Technical data	40
11.1	Specifications (DINION IP starlight 8000 MP)	40
11.2	Specifications (DINION IP ultra 8000 MP)	46

Environmental	
Operating Humidity	20% to 93% RH
Storage Humidity	up to 98% RH

1 Safety

1.1 Safety message explanation



Caution!

Indicates a hazardous situation which, if not avoided, could result in minor or moderate injury.



Notice!

Indicates a situation which, if not avoided, could result in damage to the equipment or environment, or data loss.

1.2 Safety precautions



Caution!

The Low Voltage power supply unit must comply with EN/UL 60950. The power supply must be a SELV-LPS unit or a SELV - Class 2 unit (Safety Extra Low Voltage - Limited Power Source).



Caution!

Use **only** a +12 VDC power supply as an auxiliary power source. The auxiliary power supply unit must be isolated from earth.



Caution!

Installation should only be performed by qualified service personnel in accordance with the National Electrical Code (NEC 800 CEC Section 60) or applicable local codes.

1.3 Important safety instructions

Read, follow, and retain for future reference all of the following safety instructions. Follow all warnings before operating the unit.

1. Clean only with a dry cloth. Do not use liquid cleaners or aerosol cleaners.
2. Do not install unit near any heat sources such as radiators, heaters, stoves, or other equipment (including amplifiers) that produce heat.
3. Never spill liquid of any kind on the unit.
4. Take precautions to protect the unit from power and lightning surges.
5. Adjust only those controls specified in the operating instructions.
6. Operate the unit only from the type of power source indicated on the label.
7. Unless qualified, do not attempt to service a damaged unit yourself. Refer all servicing to qualified service personnel.
8. Install in accordance with the manufacturer's instructions in accordance with applicable local codes.
9. Use only attachments/accessories specified by the manufacturer.

Network	
Ethernet	10/100 Base-T, auto-sensing, half/full duplex
Connectivity	ONVIF Profile S, Auto-MDIX

Optical	
Lens mount	Factory mounted
Lens type (NBN-80122-F6A)	5 mm, fixed-focus, fixed-iris lens (70 deg FoV) with minimum object distance of 1.1 m (3.6 ft)
Lens type (NBN-80122-F2A)	3.2 mm, fixed-focus, fixed-iris lens (120 deg FoV) with minimum object distance of 0.45 m (1.5 ft)

Mechanical	
Dimensions (W x H x L)	78 x 66 x 200 mm (3.07 x 2.6 x 7.87 inch) with factory-mounted lens
Weight	860 g (1.90 lb) with 3.2 mm lens 870 g (1.92 lb) with 5 mm lens
Color	RAL 9006 Metallic Titanium
Tripod Mount	Bottom and top 1/4-inch 20 UNC

Environmental	
Operating Temperature	-20°C to +50°C (-4°F to 122°F)
Storage Temperature	-30°C to +70°C (-22°F to +158°F)

Input/output	
Ethernet	RJ45
Data port	RS-232/422/485
Local storage	
Internal RAM	10 s pre-alarm recording
Memory card slot	Supports up to 32 GB microSDHC / 2 TB microSDXC card. (An SD card of Class 6 or higher is recommended for HD recording)
Recording	Continuous recording, ring recording, alarm/events/schedule recording
Software	
Unit Configuration	Via web browser or Configuration Manager
Firmware update	Remotely programmable
Software viewer	Web browser, Bosch Video Client, or third party software
Network	
Protocols	IPv4, IPv6, UDP, TCP, HTTP, HTTPS, RTP/RTCP, IGMP V2/V3, ICMP, ICMPv6, RTSP, FTP, Telnet, ARP, DHCP, NTP (SNTP), 802.1x, DNS, DNSv6, DDNS (DynDNS.org, selfHOST.de, no-ip.com), SMTP, iSCSI, UPnP (SSDP), DiffServ (QoS), LLDP, SOAP, Dropbox, CHAP, digest authentication
Encryption	TLS 1.0, SSL, DES, 3DES, AES (optional)

1.4 FCC and ICES compliance

FCC & ICES Information

This equipment has been tested and found to comply with the limits for a **Class B** digital device, pursuant to *part 15* of the *FCC Rules*. These limits are designed to provide reasonable protection against harmful interference in a **residential installation**. This equipment generates, uses, and can radiate radio frequency energy and, if not installed and used in accordance with the instructions, may cause harmful interference to radio communications. However, there is no guarantee that interference will not occur in a particular installation. If this equipment does cause harmful interference to radio or television reception, which can be determined by turning the equipment off and on, the user is encouraged to try to correct the interference by one or more of the following measures:

- reorient or relocate the receiving antenna;
- increase the separation between the equipment and receiver;
- connect the equipment into an outlet on a circuit different from that to which the receiver is connected;
- consult the dealer or an experienced radio/TV technician for help.

Intentional or unintentional modifications, not expressly approved by the party responsible for compliance, shall not be made. Any such modifications could void the user's authority to operate the equipment. If necessary, the user should consult the dealer or an experienced radio/television technician for corrective action.

The user may find the following booklet, prepared by the Federal Communications Commission, helpful: How to Identify and Resolve Radio-TV Interference Problems. This booklet is available from the U.S. Government Printing Office, Washington, DC 20402, Stock No. 004-000-00345-4.

1.5 Notices



Notice!

Optical elements are sensitive and should be protected at all times. Do not allow objects to come into contact with glass surfaces and do not touch optical elements with your fingers.



Notice!

Video loss is inherent to digital video recording; therefore, Bosch Security Systems cannot be held liable for any damage that results from missing video information.

To minimize the risk of losing information, we recommend multiple, redundant recording systems, and a procedure to back up all analog and digital information.



Notice!

We recommend that memory cards only be used for local storage of alarm recordings.

Video functions	
User modes	9 modes
Other functions	Image flip, Pixel counter, Video watermarking, Display stamping

Audio streaming	
Standard	G.711, 8 kHz sampling rate L16, 16 kHz sampling rate AAC-LC, 48 kHz sampling rate AAC-LC, 80 kHz sampling rate
Signal-to-Noise Ratio	>50 dB
Audio Streaming	Full-duplex / half duplex

Input/output	
Analog video out	SMB connector, CVBS (PAL/NTSC), 1 Vpp, 75 Ohm (service only)
Audio line in	1 Vrms max, 18 kOhm typical,
Audio line out	0.85 Vrms at 1.5 kOhm typical,
Audio connectors	3.5 mm mono jack
Alarm input	2 inputs
Alarm input activation	+5 VDC nominal; +40 VDC max. (DC-coupled with 50 kOhm pull-up resistor to +3.3 VDC) (< 0.5 V is low; > 1.4 V is high)
Alarm output	1 output
Alarm output voltage	30 VAC or +40 VDC max. Maximum 0.5 A continuous, 10VA (resistive load only)

Video resolution (H x V)	
288p SD	512 x 288
240p SD	Encoding: 352 x 240; Displayed: 432 x 240
144p SD	256 x 144

Video functions	
Day/Night	Color, Monochrome, Auto
Adjustable picture settings	Contrast, Saturation, Brightness
White Balance	2500 to 10000K, 4 automatic modes (Standard, SON/SOX, Basic, Dominant color), Manual mode and Hold mode
Shutter	Automatic Electronic Shutter (AES) Fixed (selectable) Default shutter
Backlight compensation	Off, Auto, intelligent Auto Exposure (iAE)
Noise reduction	intelligent Dynamic Noise Reduction (iDNR) with separate temporal and spatial adjustments
Contrast enhancement	On/off
Sharpness	Sharpness enhancement level selectable
Privacy Masking	Four independent areas, fully programmable
Video Motion Analysis	Intelligent Video Analysis (IVA)

2 Short information

This manual has been compiled with great care and the information it contains has been thoroughly verified. The text was correct at the time of printing, however the content can change without notice. Bosch Security Systems accepts no liability for damage resulting directly or indirectly from faults, incompleteness or discrepancies between this manual and the product described.

Trademarks

All hardware and software product names used in this document are likely to be registered trademarks and must be treated accordingly.

More information

For more information please contact the nearest Bosch Security Systems location or visit www.boschsecurity.com

2.1 Copyrights

This manual is the intellectual property of Bosch Security Systems and is protected by copyright.
All rights reserved.

3 System overview

The DINION IP 8000 family consists of the following cameras:

- DINION IP starlight 8000 MP for high-performance in challenging light conditions
- DINION IP ultra 8000 MP for ultra high-definition

These IP cameras operate as network video servers and transmit video and control signals over Ethernet LANs and the Internet. The integrated encoder uses H.264 compression technology to give clear images while reducing bandwidth and storage requirements.

3.1 Application variants

The camera has a choice of application variants that set up the camera for optimum performance in a specific environment. Select the application variant best suited to your installation. The application variant must be selected before any other changes are made, as the camera reboots automatically and resets the factory defaults when the application variant is changed.

The DINION IP ultra 8000 MP has three application variants:

- 4K UHD
- 12MP (4:3)
- 1080p

The DINION IP starlight 8000 MP has three application variants:

- 5MP (16:9)
- 5MP (4:3)
- 1080p

3.2 Using the camera

To access the features of the camera, use a web browser. The browser provides live viewing of the camera streams in the interface window, and also allows you to access and change the

Video performance – Sensitivity (3200K, 89% reflectivity, 30% IRE, 33 ms, F2.45), scene illumination	
Mono (12MP / 4K UHD mode)	0.638 lx
Mono (1080p mode)	0.328 lx

Video streaming	
Video compression	H.264 (MP); M- JPEG
Streaming	Multiple configurable streams in H.264 and M-JPEG, configurable frame rate and bandwidth. Regions of Interest (ROI)
Overall IP Delay	Min. 120 ms, Max. 340 ms
GOP structure	IP, IBP, IBBP
Encoding interval	1 to 25 [30] ips

Video resolution (H x V)	
12MP	4000 x 3000 (at 20 fps)
4K UHD	3840 x 2160 (at 30 fps)
1080p HD	1920 x 1080 (at 30 fps)
720p HD	1280 x 720 (at 30 fps)
D1 4:3 (downscaled/ cropped)	704 x 480
480p SD	Encoding: 704 x 480; Displayed: 854 x 480
432p SD	768 x 432

11.2 Specifications (DINION IP ultra 8000 MP)

Power	
Power Supply	12 VDC Power-over-Ethernet 48 VDC nominal
Current Consumption	750 mA (12 VDC) 200 mA (PoE 48 VDC)
Power Consumption	9 W
PoE	IEEE 802.3af (802.3at Type 1) Class 3
Sensor	
Type	1/2.3-inch CMOS
Pixels	12 MP
Video performance - Dynamic range	
12 MP (4:3) mode	92 dB WDR (92+16 dB with iAE)
4K UHD (16:9) mode	92 dB WDR (92+16 dB with iAE)
1080p mode	98 dB WDR (98+16 dB with iAE)
Video performance – Sensitivity (3200K, 89% reflectivity, 30% IRE, 33 ms, F2.45), scene illumination	
Color (12MP / 4K UHD mode)	1.932 lx
Color (1080p mode)	0.966 lx

extensive list of settings and parameters for camera configuration. Refer to the software manual for more information on the browser interface.

The camera recording and storage functions include local alarm recording and recording to iSCSI-based systems. The camera can also use the Bosch Video Recording Manager (VRM) to control recording and storage. Integration with the many Bosch recording solutions is seamless.

3.3 Operation with external systems

Using a web browser to access the camera's video streams and functions is the most direct way of using the camera. The free-of-charge Bosch Video Client can be used for multiple-camera viewing, playback and configuration. A Bosch video security mobile App is also available for remote viewing.

If the camera is used in larger surveillance systems, the Bosch Video Management System offers a perfect integrated solution. Third-party integrators can easily access the internal feature set of the camera for integration into large projects. Access to IVA metadata is available to integrators via RTSP.

When connected to external systems, many of the camera configuration parameters are controlled by the system and not by the settings made via a web browser.

Bosch Video Client

The Bosch Video Client is a free Windows application for viewing, operating, controlling, and administering surveillance cameras and installations at remote locations. It offers a user-friendly interface for easy live viewing of multiple cameras, playback, forensic search and export.

Bosch Video Management System

The Bosch Video Management System is a unique enterprise IP video surveillance solution that provides seamless management of digital video, audio and data across any IP network. It is designed to work with Bosch security products as part of a total video surveillance management system.

4 Planning information

4.1 Unpacking

Unpack carefully and handle the equipment with care. The packaging contains:

- DINION IP 8000 camera
- Quick install instructions
- Power connector
- Data/Alarm connector
- Identification labels
- CS mount adapter ring for mounting a lens with a C-mount (only for DINION IP starlight 8000 MP)

If equipment has been damaged during shipment, repack it in the original packaging and notify the shipping agent or supplier.

4.2 System requirements

- Computer with Windows XP/Vista/7 operating system, network access, and Microsoft Internet Explorer web browser version 9.0 or later (32-bit)
- **-or-**
- Computer with network access and reception software, for example Bosch Video Client and Bosch Video Management System

Software	
Unit Configuration	Via web browser or Configuration Manager
Firmware update	Remotely programmable
Software viewer	Web browser, Bosch Video Client, or third party software

Optical	
Lens mount	CS mount (C-mount with adapter ring)
Lens connector	Standard 4-pin DC-iris connector
Focus control	Motorized back-focus adjustment
Iris control	Automatic iris control

Mechanical	
Dimensions (W x H x L)	78 x 66 x140 mm (3.07 x 2.6 x 5.52 inch) without lens
Weight	855 g (1.88 lb) without lens
Color	RAL 9006 Metallic Titanium
Tripod Mount	Bottom and top 1/4-inch 20 UNC

Environmental	
Operating Temperature	-20°C to +50°C (-4°F to 122°F)
Storage Temperature	-30°C to +70°C (-22°F to +158°F)
Operating Humidity	20% to 93% RH
Storage Humidity	up to 98% RH

Input/output	
Ethernet	RJ45
Data port	RS-232/422/485

Local storage	
Internal RAM	10 s pre-alarm recording
Memory card slot	Supports up to 32 GB microSDHC / 2 TB microSDXC card. (An SD card of Class 6 or higher is recommended for HD recording)
Recording	Continuous recording, ring recording, alarm/events/schedule recording

Network	
Protocols	IPv4, IPv6, UDP, TCP, HTTP, HTTPS, RTP/RTCP, IGMP V2/V3, ICMP, ICMPv6, RTSP, FTP, Telnet, ARP, DHCP, NTP (SNTP), 802.1x, DNS, DNSv6, DDNS (DynDNS.org, selfHOST.de, no-ip.com), SMTP, iSCSI, UPnP (SSDP), DiffServ (QoS), LLDP, SOAP, Dropbox, CHAP, digest authentication
Encryption	TLS 1.0, SSL, DES, 3DES, AES (optional)
Ethernet	10/100 Base-T, auto-sensing, half/full duplex
Connectivity	ONVIF Profile S, Auto-MDIX

5 Installation

The DINION IP ultra 8000 MP has a factory fitted lens and requires no lens mounting during installation.

5.1 Lens mounting

DINION IP starlight 8000 MP only

Remove the sensor protection cap before mounting the lens.



Notice!

Lenses weighing more than 0.5 kg (1.1lbs) must be separately supported.

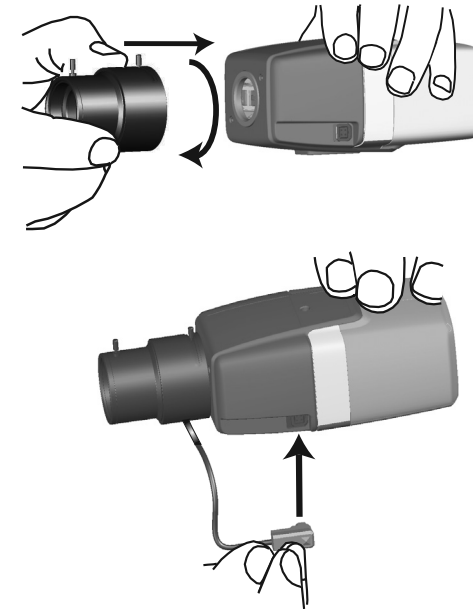

The camera accepts CS or C-mount lenses (use the adapter ring to attach a C-mount lens). DC-iris lenses are recommended for best performance. The camera automatically detects the type of lens and optimizes performance accordingly.

Note:

If a short circuit is detected on the lens connector, the lens circuit is automatically disabled to avoid internal damage. Remove the lens connector and check the pin connections.

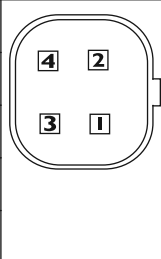
Pin	DC iris lens	
1	Damp -	
2	Damp +	
3	Drive +	
4	Drive -	

Video functions	
User modes	9 modes
Other functions	Image flip, Pixel counter, Video watermarking, Display stamping

Audio streaming	
Standard	G.711, 8 kHz sampling rate L16, 16 kHz sampling rate AAC-LC, 48 kHz sampling rate AAC-LC, 80 kHz sampling rate
Signal-to-Noise Ratio	>50 dB
Audio Streaming	Full-duplex / half duplex

Input/output	
Analog video out	SMB connector, CVBS (PAL/NTSC), 1 Vpp, 75 Ohm (service only)
Audio line in	1 Vrms max, 18 kOhm typical,
Audio line out	0.85 Vrms at 1.5 kOhm typical,
Audio connectors	3.5 mm mono jack
Alarm input	2 inputs
Alarm input activation	+5 VDC nominal; +40 VDC max. (DC-coupled with 50 kOhm pull-up resistor to +3.3 VDC) (< 0.5 V is low; > 1.4 V is high)
Alarm output	1 output
Alarm output voltage	30 VAC or +40 VDC max. Maximum 0.5 A continuous, 10VA (resistive load only)

Video resolution	
240p SD	Encoding: 352 x 240; Displayed: 432 x 240
144p SD	256 x 144

Video functions	
Day/Night	Color, Monochrome, Auto
Adjustable picture settings	Contrast, Saturation, Brightness
White Balance	2500 to 10000K, 4 automatic modes (Standard, SON/SOX, Basic, Dominant color), Manual mode and Hold mode
Shutter	Automatic Electronic Shutter (AES) Fixed (selectable) Default shutter
Backlight compensation	Off, Auto, intelligent Auto Exposure (iAE)
Noise reduction	intelligent Dynamic Noise Reduction (iDNR) with separate temporal and spatial adjustments
Contrast enhancement	On/off
Sharpness	Sharpness enhancement level selectable
Privacy Masking	Four independent areas, fully programmable
Video Motion Analysis	Intelligent Video Analysis (IVA)

5.2 Mounting the camera



Notice!

Do not expose the image sensors to direct sunlight.
Do not obstruct the free flow of air around the camera.

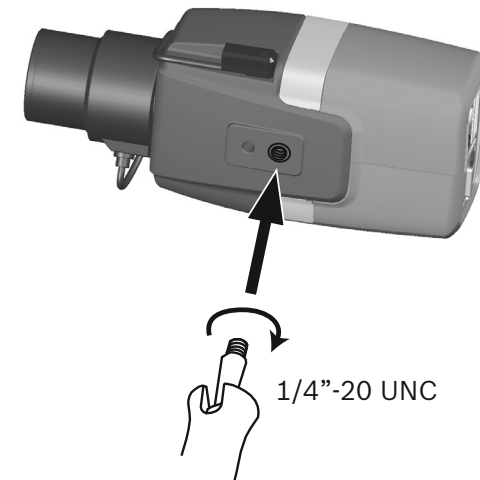

The camera can be mounted either from the top or from the bottom (1/4" 20 UNC thread).

5.3 Local storage

Notice!



Local storage on SD cards should only be used for alarm recording. To minimize the risk of losing information, use multiple, redundant recording systems and a procedure to back up all digital information.

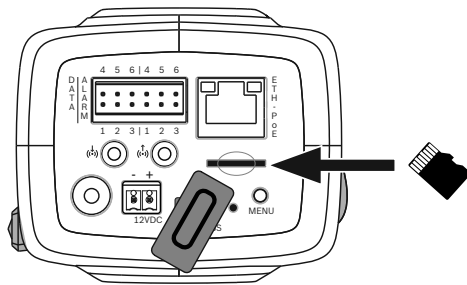

1. Unscrew the card slot cover.
2. Slide the memory card into the slot until it locks in place.
3. Screw the cover into place to seal the slot.

Video performance – Sensitivity (3200K, 89% reflectivity, 30% IRE, F1.2)

Mono 5MP mode	0.004 lx
Mono 1080p mode	0.00275 lx

Video streaming

Video compression	H.264 (MP); M- JPEG
Streaming	Multiple configurable streams in H.264 and M-JPEG, configurable frame rate and bandwidth. Regions of Interest (ROI)
Overall IP Delay	Min. 120 ms, Max. 340 ms
GOP structure	IP, IBP, IBBP
Encoding interval	1 to 25 [30] ips

Video resolution

5MP (16:9)	2992 X 1680
5MP (4:3)	2704 X 2032
1080p HD	1920 X 1080
720p HD	1280 x 720
Upright 9:16 (cropped)	400 x 720
D1 4:3 (cropped)	704 x 480
480p SD	Encoding: 704 x 480; Displayed: 854 x 480
432p SD	768 x 432
288p SD	512 x 288

11 Technical data

11.1 Specifications (DINION IP starlight 8000 MP)

Power	
Power Supply	12 VDC Power-over-Ethernet 48 VDC nominal
Current Consumption	750 mA (12 VDC) 200 mA (PoE 48 VDC)
Power Consumption	9 W
PoE	IEEE 802.3af (802.3at Type 1) Class 3

Sensor	
Type	1/1.8" CMOS
Total sensor pixels	6.1 MP

Video performance - Dynamic range	
5MP (4:3) mode	97 dB WDR (97+16 dB with iAE)
5MP (16:9) mode	97 dB WDR (97+16 dB with iAE)
1080p mode	103 dB WDR (103+16 dB with iAE)

Video performance – Sensitivity (3200K, 89% reflectivity, 30% IRE, F1.2)	
Color 5MP mode	0.0121 lx
Color 1080p mode	0.00825 lx

6 Connection



Caution!

Installation should only be performed by qualified service personnel in accordance with the National Electrical Code (NEC 800 CEC Section 60) or applicable local codes.

6.1 Network (and PoE power) connector

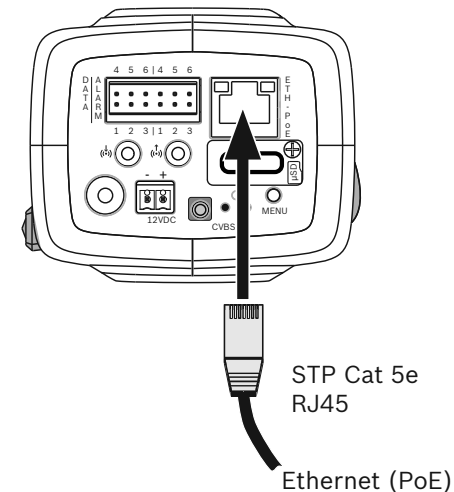

Connect the camera to a 10/100 Base-T network:

- Use STP Category 5e cable with RJ45 connectors (the camera network socket is Auto MDIX compliant).
- Power can be supplied to the camera via the Ethernet cable compliant with the Power-over-Ethernet standard.

The LEDs beside the Ethernet connection indicate Power (red), IP connection (green) and IP traffic (green flashing).



Notice!

Use only PoE approved devices.

Power-over-Ethernet can be connected at the same time as a 12 VDC power supply. If auxiliary power (12 VDC) and PoE is applied simultaneously, the camera selects PoE and shuts off the auxiliary input.

10 Decommissioning

10.1 Transfer

The camera should only be passed on together with this installation guide.

10.2 Disposal



Disposal - Your Bosch product was developed and manufactured with high-quality material and components that can be recycled and reused. This symbol means that electronic and electrical appliances, which have reached the end of their working life, must be collected and disposed of separately from household waste material. Separate collecting systems are usually in place for disused electronic and electrical products. Please dispose of these units at an environmentally compatible recycling facility, per *European Directive 2002/96/EC*

9 Maintenance

9.1 Cleaning

It is generally sufficient to use a dry cloth for cleaning, but a moist lint-free cloth or leather shammy may also be used. Do not use liquid cleaners or aerosol cleaners.

9.2 Reset

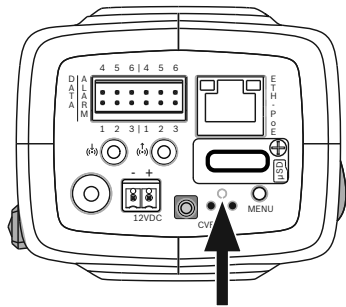

Use the factory reset button to restore the unit to its original settings. Any changes to the settings are overwritten by the factory defaults. A reset may be necessary, for example, if the unit has invalid settings that prevent it from functioning as desired.

9.3 Repair



Notice!

Never open the casing of the unit

The unit does not contain any user-serviceable parts. Refer all repairs to suitable qualified specialists.

6.2 Auxiliary power connector



Caution!

The Low Voltage power supply unit must comply with EN/UL 60950. The power supply must be a SELV-LPS unit or a SELV - Class 2 unit (Safety Extra Low Voltage - Limited Power Source).



Caution!

Use **only** a +12 VDC power supply as an auxiliary power source. The auxiliary power supply unit must be isolated from earth.

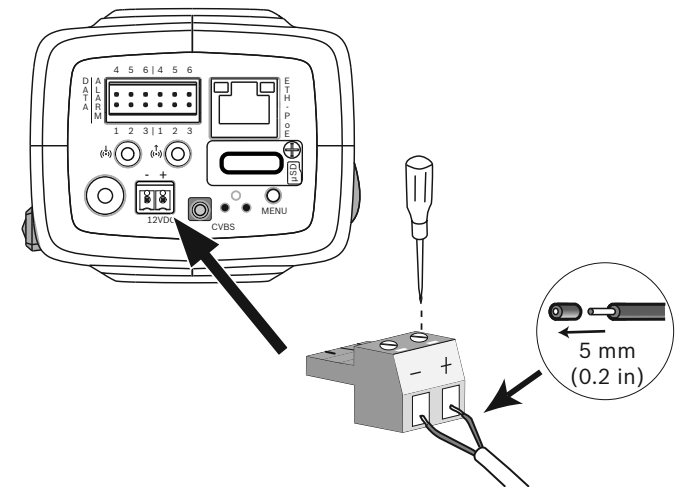

Connect an approved power supply unit with a rated supply voltage of 12 VDC as follows:

1. Strip back 5 mm (0.2 in) of insulation on the power supply cable (must be 16-22 AWG stranded wire or 16-26 AWG solid wire).
2. Loosen the screws of the supplied 2-pole connector and insert the stripped wires, before tightening the screws again.
3. Insert the 2-pole connector into the camera power socket.

6.3 Alarm input and output connector

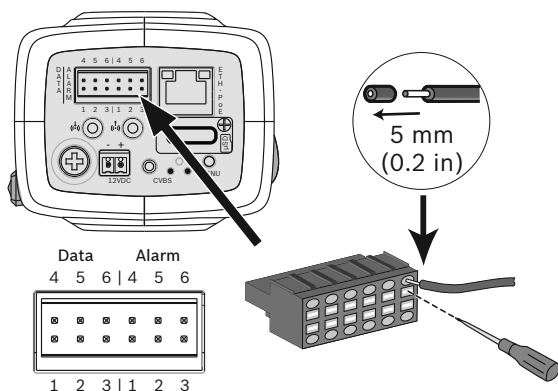

Pin	Alarm socket
1	Alarm in 1
2	Alarm in 2
3	Alarm out contact 1
4	Ground
5	Ground
6	Alarm out contact 2

Use stranded and solid wire with maximum diameter AWG 22-28; only cut back 5 mm (0.2 in) of insulation.

Alarm out:

Use the alarm output for switching external devices such as lamps or sirens.

The alarm output switching capability has max. voltage 30 VAC or +40 VDC; max. 0.5 A continuous, 10 VA.

Alarm in:

Use the alarm input to connect external alarm devices such as door contacts or sensors:

Assigning an IP Address

Before you can operate a camera in your network you must first assign it an IP address that is valid for your network.

The following default address is preset at the factory:

192.168.0.1

1. Start a terminal program such as HyperTerminal.
2. Enter the user name service. The terminal program displays the main menu.
3. Enter command 1 to open the IP menu.
4. Enter 1 again. The terminal program displays the current IP address and prompts you to enter a new IP address.
5. Enter the desired IP address and press Enter. The terminal program displays the new IP address.
6. Use the displayed commands for any additional settings you require.

Note:

You must reboot to activate the new IP address, a new subnet mask or a gateway IP address.

Reboot

Briefly interrupt the power supply to the camera for a reboot (disconnect the power supply unit from the mains supply and switch on again after a few seconds).

Additional Parameters

You can use the terminal program to check other basic parameters and modify them where necessary. Use the on-screen commands in the various submenus to do this.

8.5 Terminal program

Data Terminal

If a camera cannot be found in the network or the connection to the network is interrupted, you can connect a data terminal to the camera for initial setup and for setting important parameters. The data terminal consists of a computer with a terminal program.

You require a serial transmission cable with a 9-pin Sub-D plug to connect to the computer.

The communications accessory included with Windows can be used as the terminal program.

1. Disconnect the camera from the Ethernet network before working with the terminal program.
2. Connect the serial interface of the camera using any available serial interface on the computer.

Configuring the Terminal

Before the terminal program can communicate with the camera, the transmission parameters must be matched. Make the following settings for the terminal program:

- 19,200 bps
- 8 data bits
- No parity check
- 1 stop bit
- No protocol

Command Inputs

After the connection has been established, you must log on to the camera to access the main menu. Other submenus and functions can be accessed using the on-screen commands.

1. If necessary, turn off the local echo so that entered values are not repeated on the display.
2. Enter one command at a time.
3. When you have entered a value, such as the IP address, check the characters you have entered before pressing Enter to transfer the values to the camera.

- TTL logic, +5 V nominal, +40 VDC max, DC coupled with 50 kOhm pull-up to +3.3 V.
- Configurable as active low or active high.

Use a zero potential make-contact or switch as the actuator (with a bounce-free contact system).

Note:

If IR illumination is used, the alarm interface provides a stable switching control for the day/night function of the camera.

6.4 Audio connectors

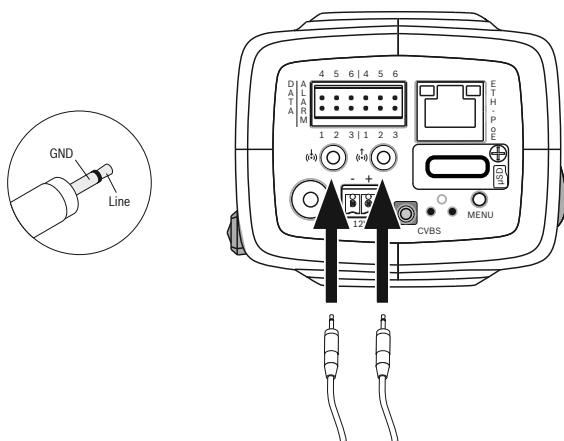

Connect audio devices to the **Audio In** and **Audio Out** connectors.

The unit has full-duplex mono audio for two-way communication between a speaker or door intercom system. The audio input signal is transmitted in sync. with the video signal.

Audio input: Line input level (not suitable for direct microphone signal); impedance 18 kOhm typical; 1 Vrms maximum input voltage.

Audio output: Line output level (not suitable for direct speaker connection); impedance 1.5 kOhm minimum; 0.85 Vrms maximum output voltage.

Wiring: Use shielded audio connection cable with advised maximum cable lengths for audio line input and output levels.

8.3 Testing the network connection

The ping command can be used to check the connection between two IP addresses. This allows testing whether a device is active in the network.

1. Open the DOS command prompt.
2. Type `ping` followed by the IP address of the device.

If the device is found, the response appears as "Reply from ... ", followed by the number of bytes sent and the transmission time in milliseconds. Otherwise, the device cannot be accessed via the network. This might be because:

- The device is not properly connected to the network. Check the cable connections in this case.
- The device is not correctly integrated into the network. Check the IP address, subnet mask, and gateway address.

8.4 Customer service

If a fault cannot be resolved, please contact your supplier or system integrator, or go directly to Bosch Security Systems Customer Service.

The version numbers of the internal firmware can be viewed on a service page. Please note this information before contacting Customer Service.

1. In the address bar of your browser, after the unit IP address, enter: `/version`
for example: `192.168.0.80/version`
2. Write down the information or print out the page.

Malfunction	Possible causes	Solution
	Incorrect firmware file.	Enter the IP address of the unit followed by /main.htm in your Web browser and repeat the upload.
Placeholder with a red cross instead of the ActiveX components.	JVM not installed on your computer or not activated.	Install JVM.
Web browser contains empty fields.	Active proxy server in network.	Create a rule in the local computer's proxy settings to exclude local IP addresses.
The POWER LED flashes red.	Firmware upload failed.	Repeat firmware upload.

6.5 Video monitor connector

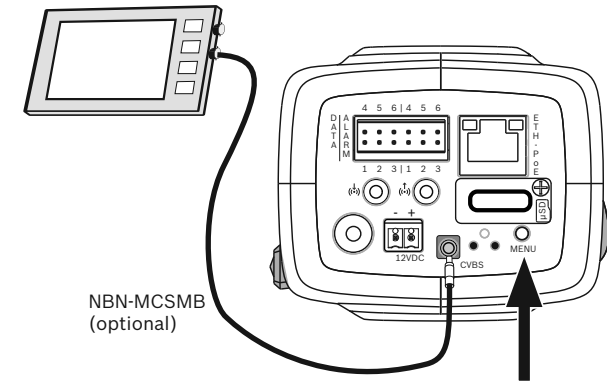

Use the SMB video connector (CVBS) to connect an analog monitor for setting up the camera:

- To connect a monitor, use the optional 3 m cable (NBN-MCSMB-03M) to connect directly to the CVBS connector of a monitor.
- To connect to a coax cable, use the optional 0.3 m cable (NBN-MCSMB-30M).

6.6 Data connector

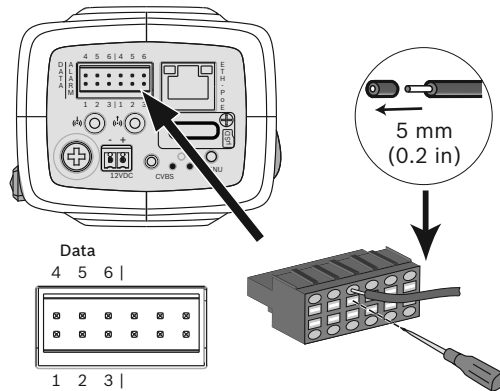

Pin	Data socket
1	Ground
2	RxD / Rx+
3	Rx-
4	Ground
5	TxD / Tx-
6	Tx+

Use the data connector to connect to an external device for sending control data from the camera to the external device. This data connection supports RS485, RS422, and RS232.

Note:

To ensure surge and electrostatic protection, keep the cable length between the camera and external device to less than 3 meters.

Malfunction	Possible causes	Solution
	The audio voice connection is already in use by another receiver.	Wait until the connection is free and then call the sender again.
The unit does not report an alarm.	Alarm source is not selected.	Select possible alarm sources on the Alarm sources configuration page.
	No alarm response specified.	Specify the desired alarm response on the Alarm connections configuration page; if necessary change the IP address.
Control of cameras or other units is not possible.	The cable connection between the serial interface and the connected unit is not correct.	Check all cable connections and ensure all plugs are properly fitted.
	The interface parameters do not match those of the other unit connected.	Make sure that the settings of all units involved are compatible.
The unit is not operational after a firmware upload.	Power failure during programming by firmware file.	Have the unit checked by Customer Service and replace if necessary.

Malfunction	Possible causes	Solution
No connection established, no image transmission.	Incorrect unit configuration.	Check all configuration parameters (reset to factory default if necessary).
	Faulty installation.	Check all cables, plugs, contacts and connections.
	Wrong IP address.	Check the IP addresses (terminal program).
	Faulty data transmission within the LAN.	Check the data transmission with ping.
	The maximum number of connections has been reached.	Wait until there is a free connection and call the transmitter again.
No audio transmission to remote station.	Hardware fault.	Check that all connected audio units are operating correctly.
	Faulty cable connections.	Check all cables, plugs, contacts and connections.
	Incorrect configuration.	Check audio parameters on the Audio configuration and LIVEPAGE Functions pages.

7 Configuration

7.1 Setting the field of view

When the camera is mounted and connected, its field of view and focus point must be set. To do this:

1. Connect a monitor to the CVBS connector on the rear of the camera.
2. Start the install wizard.

7.1.1 Camera install wizard

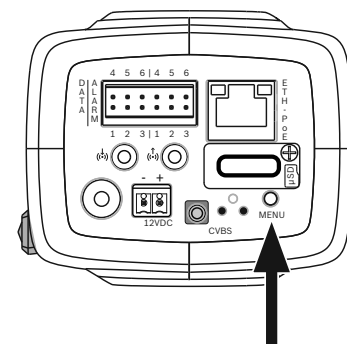

The **MENU** button on the rear panel is used for accessing the camera install wizard. The wizard fine-tunes the focus and optimizes picture sharpness in both bright and low-level lighting (for example, at night).

When there is a choice in the wizard, the options are selected by either a short press or a longer press of the **MENU** button. Select **EXIT** to close the wizard.

7.1.2 Using the install wizard



Notice!

Changing the application variant overwrites your camera settings with the factory defaults.

DINION IP starlight 8000 MP

1. Power-up the camera and wait momentarily for it to start.
2. Briefly press the **MENU** button to open the wizard and display the following screen on the monitor:

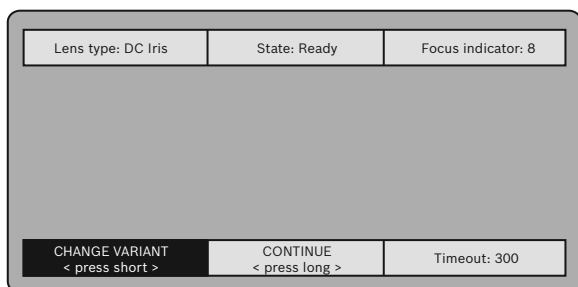

The lens type is identified and shown on the screen.

The iris is opened to its maximum value.

3. If required, change the camera application variant as follows:

Briefly press **MENU** until the required variant is displayed.

Choices are 1080p, 5MP (4:3) or 5MP (16:9).

Assign the setting by pressing **MENU** for a longer time.

Confirm the setting by pressing **MENU** for a longer time.

The camera will reboot and assign the factory defaults for that variant.

4. When the variant is set correctly, briefly press **MENU** to continue to the following screen:

8 Troubleshooting

8.1 Function test

The camera offers a variety of configuration options. Therefore, check that it works properly after installation and configuration. This is the only way to ensure that the camera will function as intended in the event of an alarm.

Your check should include the following functions:

- Can you connect to the camera remotely
- Does the camera transmit all the data required?
- Does the camera respond as desired to alarm events?
- Is it possible to control peripheral devices, if necessary?

8.2 Resolving problems

The following table is intended to help identify the causes of malfunctions and correct them where possible.

Malfunction	Possible causes	Solution
No image transmission to remote location.	Defective camera.	Connect a local monitor to the camera and check the camera function.
	Faulty cable connections.	Check all cables, plugs, contacts and connections.
	Incorrect encoder stream property set for connection to hardware decoder.	Select the H.264 MP SD option on the Encoder Streams configuration page.

7.3 Camera configuration

The camera normally provides an optimal picture without the need for further adjustments. Configuration of the camera is carried out via the network using a web browser. The camera has a settings menu in which installation settings (such as user modes, passwords, picture settings or network settings, etc.) can be changed.

The configuration options using the menu system of the camera itself are limited to setting up the field of view.

7.4 Browser connection

A computer with Microsoft Internet Explorer is used to receive live images, control the unit, and replay stored sequences. The unit is configured over the network using the browser.

7.4.1 Establishing the connection

The unit must have a valid IP address to operate on your network and a compatible subnet mask. By default, DHCP is pre-set at the factory to **On** and so your DHCP server assigns an IP address. With no DHCP server the default address is 192.168.0.1

1. Start the Web browser.
2. Enter the IP address of the unit as the URL.
3. During initial installation, confirm any security questions that appear.

7.4.2 Protected network

If a RADIUS server is used for network access control (802.1x authentication), the unit must be configured first. To configure the unit, connect it directly to a computer using a network cable and configure the two parameters, **Identity** and **Password**. Only after these have been configured can communication with the unit via the network occur.

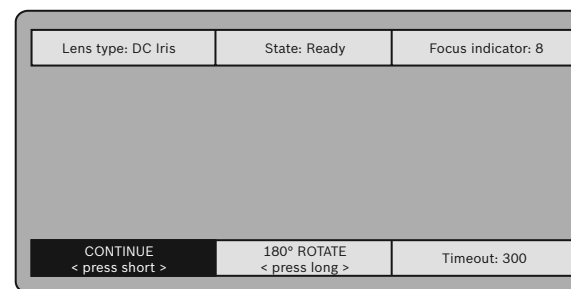

5. To rotate the image 180°, press **MENU** for a longer time until the image flips.
6. Briefly press **MENU** to continue.
7. Briefly press **MENU** to center the focus.
8. Use the manual adjust levers on the lens to obtain the required field of view and the sharpest image possible.

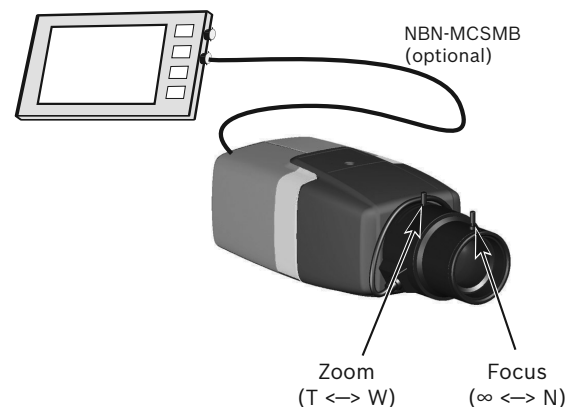

9. Briefly press **MENU** to start the automatic back focus adjustment (AUTO BACK FOCUS). The motorized automatic back focus process runs. The progress is shown on the monitor.
10. If the camera is not in focus, press **MENU** for a longer time to restart the wizard.
11. If the camera is correctly focused, briefly press **MENU** to exit the wizard.

DINION IP ultra 8000 MP

1. Power-up the camera and wait momentarily for it to start.
2. Briefly press the **MENU** button to open the wizard and display the following screen on the monitor:

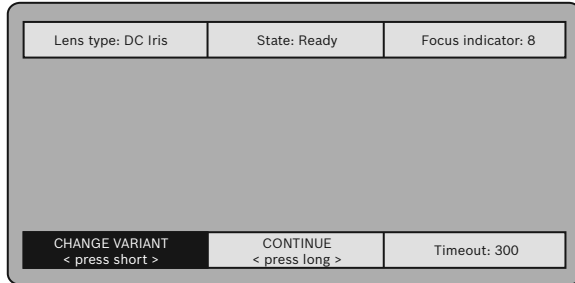

The lens type is identified and shown on the screen.
The iris is opened to its maximum value.

3. If required, change the camera application variant as follows:
Briefly press **MENU** until the required variant (1080p, 4K UHD or 12MP) is displayed.
Assign the setting by pressing **MENU** for a longer time.
Confirm the setting by pressing **MENU** for a longer time.
The camera will reboot and assign the factory defaults for that variant.
4. When the variant is set correctly, briefly press **MENU** to continue to the following screen:

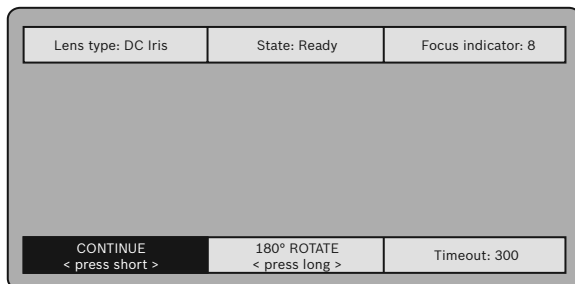

5. To rotate the image 180°, press **MENU** for a longer time until the image flips.
6. Briefly press **MENU** to continue.

7. Briefly press **MENU** to center the focus.
8. Briefly press **MENU** to start the automatic back focus adjustment (AUTO BACK FOCUS).
The motorized automatic back focus process runs.
The progress is shown on the monitor.
9. If the camera is not in focus, press **MENU** for a longer time to restart the wizard.
10. If the camera is correctly focused, briefly press **MENU** to exit the wizard.

7.2 True Day/Night switching

The camera is equipped with a motorized IR filter. This mechanical IR filter is taken out of the optical path in low-light conditions.

The IR filter is controlled either:

- via an alarm input, or
- automatically, based on the observed light levels.

If **Auto** switching mode is selected, the camera automatically switches the filter depending on the observed light level. The switching level is adjustable. (If the day to night switching level is set to -15, certain borderline scene lighting conditions can cause the camera to switch back and forth between day and night modes. Set a different switching level to avoid this.)

Note:

If IR illumination is used, the alarm interface provides a stable switching control for the day/night function of the camera.