

NUV-3703-F02 Micro dome 5MP HDR 131°

FLEXIDOME micro 3100i



- ▶ Compact design for discreet indoor use with quick and easy installation and set-up
- ▶ 5 MP for highly detailed images
- ▶ IVA Pro Buildings brings reliable deep-learning based detection of persons and vehicles
- ▶ High Dynamic Range (HDR) to see every detail in both bright and dark areas of the scene
- ▶ Built-in Secure Element with Trusted Platform Module (TPM) to ensure the highest level of security for device access and data transport

The FLEXIDOME micro 3100i is discreet and compact by design, offering high-quality imaging for 24/7 surveillance.

It includes IVA Pro Buildings deep-learning-based video analytics for reliable detection in and around buildings and a built-in Secure Element for the highest level of data security.

Unique corner and plenum-rated ceiling mounts enable discreet mounting.

Additionally, the cameras are compatible with the Bosch modular mounts.

Functions

High Dynamic Range

The camera has High Dynamic Range. This is based on a multiple-exposure process that captures more details in the highlights and in the shadows even in the same scene. The result is that you can easily distinguish objects and features, for example, faces with bright backlight.

Intelligent Video Analytics Pro (IVA Pro Buildings)

The camera comes with the IVA Pro Buildings pre-installed and brings reliable deep-learning based detection and tracking of persons and vehicles. Being resistant to false triggers caused by challenging environments with rain, wind (moving trees), snow, hail, and water reflections as well as shadows and bugs, it detects, tracks, and classifies objects.

A smart set of alarm and counter rules alerts you when predefined alarms are triggered, and enables forensic search with high efficiency through recordings. Configuration effort is minimized and made easy by removing the need for calibration.

Intelligent Streaming and H.265 encoding

The camera is designed on the most efficient and powerful H.264 and H.265/HEVC encoding platform. Intelligent streaming is capable of delivering high-quality and high-resolution video with very low network load.

With a doubling of encoding efficiency, H.265 adds even more bit-rate saving on top.

Modular accessories

A full line of modular accessories is available, which allows a consistent design across different cameras and a wide range of installation possibilities. Available options include wall or pipe mount, a corner mount box, and an in-ceiling mounting kit.

Edge recording

Insert a memory card into the card slot to store up to 2 TB of local alarm recording. Pre-alarm recording in RAM reduces recording bandwidth on the network, and extends the effective life of the memory card. It has advanced edge recording providing a reliable storage solution possible due to the combination of these functions:

- Industrial SD card support allows for extreme lifetime

- Health monitoring of industrial SD cards provide early service indications.

DORI coverage

DORI (Detect, Observe, Recognize, Identify) is a standard system (EN-62676-4) for defining the ability of a person viewing the video to distinguish persons or objects within a covered area. The maximum distance at which a camera/lens combination can meet these criteria is shown below:

5MP camera with 2.49 mm lens

DORI	DORI definition	Distance 2.49 mm	Horizontal width
Detect	25 px/m (8 px/ft)	24 m (77 ft)	104 m (340 ft)
Observe	63 px/m (19 px/ft)	9 m (31 ft)	41 m (135 ft)
Recognize	125 px/m (38 px/ft)	5 m (15 ft)	21 m (68 ft)
Identify	250 px/m (76 px/ft)	2 m (8 ft)	10 m (34 ft)

Data security

Special measures have been put in place to ensure the highest level of security for device access and data transport. The three-level password protection with security recommendations allows users to customize device access. Web browser access can be protected using HTTPS and firmware updates can also be protected with authenticated secure uploads. The cameras have built-in Secure Element (SE) hardware providing main Trusted Platform Module (TPM) functionality to ensure the highest levels of data security and privacy protection. Together with Public Key Infrastructure (PKI) support, superior protection from malicious attacks is guaranteed. The cameras also support RSA encryption key lengths of up to 4096 bits, ensuring data safety beyond 2030, as well as 802.1x network authentication with EAP/TLS. The advanced certificate handling offers:

- Bosch origin device certificate pre-installed
- Self-signed unique certificates automatically created when required
- Client and server certificates for authentication
- Client certificates for proof of authenticity
- Certificates with encrypted private keys

Bosch Remote Portal

With the secure cloud infrastructure, Bosch Remote Portal, you can manage your connected Bosch devices. From the Bosch Remote Portal you can:

- Complete initial configuration of your connected Bosch devices (online or offline).
- Update firmware for single or multiple devices.
- Manage certificates.

- Monitor the health of your connected Bosch devices.

System integration and ONVIF conformance

The camera conforms to the ONVIF Profile S, ONVIF Profile G, ONVIF Profile M, and ONVIF Profile T specifications. For H.265 configuration, the camera supports Media Service 2, which is part of ONVIF Profile T. Compliance with these standards guarantees interoperability between network video products regardless of manufacturer. Third-party integrators can easily access the internal feature set of the camera for integration into large projects. Visit the Bosch Integration Partner Program (IPP) website (ipp.boschsecurity.com) for more information.

Regulatory information

Standard	Type
Emission	EN 55032 (Class A) CFR 47 FCC part 15 (Class A) VCCI (Class A) AS/NZS CISPR32 (Class A)
Immunity	EN 55035 EN 61000-6-1 EN 61000-6-2
Environmental	IEC 60068-2-1 IEC 60068-2-2 IEC 60068-2-6 IEC 60068-2-14 IEC 60068-2-27 EN IEC 63000: 2018 RoHS EU, 2011/65/EU and 2015/863/EU WEEE EU, 2012/19/EU Packaging EU, 94/62/EU N2580-1 (Bosch standard) N33.6 (Bosch standard)
Safety	EN IEC 62368-1 IEC 62368-1 UL 62368-1
Image performance	IEC 62676-5
Color representation	ITU-R BT.709-6
ONVIF conformance	EN 50132-5-2, EN 62676-2
Impact protection	EN 62262 (IK08): 2002
Marks	CE, FCC, UL, WEEE, RCM, VCCI, UKCA, BIS, KCC, SASO, CMIM, Sweden PVC free

Standard	Type
Compliance	NDA compliant

Region	Regulatory compliance/quality marks
Europe	CE
Great Britain	UKCA

Installation/configuration notes

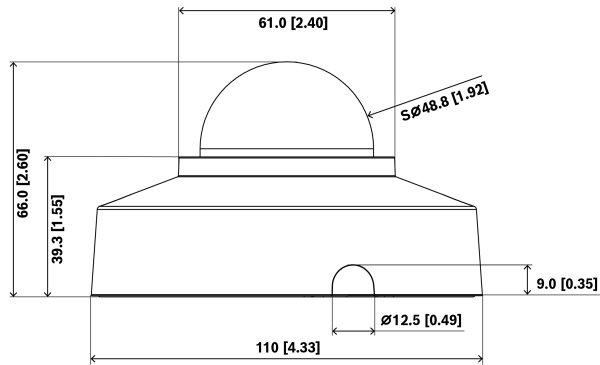

Dimensions in mm (inch)

Parts included

Quantity	Component
1	FLEXIDOME micro 3100i device
1	TR15 key
1	Mounting sticker
1	Quick installation guide
1	Safety and security information
3	Installer UX label

Technical specifications

Electrical

PoE input	PoE IEEE 802.3af / 802.3at Type 1, Class 3
Power consumption PoE (W) (typical – maximum)	3.2 W – 4.5 W

Sensor

Total sensor pixels	5 MP approx.
Sensor type	1/2.7 inch CMOS
Effective pixels (H x V)	2,592 x 1,944

Sensitivity

Color (lx) (sensitivity measured according to IEC 62676 Part 5)	0.15 lx
---	---------

Dynamic range

High Dynamic Range (HDR) (dB)	120 dB
-------------------------------	--------

Optical

Lens focal length (mm)	2.49 mm
Lens aperture (/F)	1.7 /F
Horizontal field of view (°)	131.2°
Vertical field of view (°)	91.4°

Video functions

Day/night modes	Auto (adjustable switch points); Color; Monochrome
Camera functionality	Mirror image; Rotation 90°; Rotation 180°; Rotation 270° including up-right mode; Backlight compensation (BLC); Sharpness enhancement; Intelligent defog; Pixel counter; Saturation; Brightness; Video watermarking; Display stamping; Location
White balance (K)	2,000 K – 10,000 K
White balance modes	Basic; Standard; Manual mode; Hold mode; 3 automatic modes; Sodium lamp auto
Shutter modes	Automatic Electronic Shutter (AES); 1/15,000 max; Default shutter; 1/25 [30] min
Number of privacy masks	8

Video streaming

Video compression	H.264 (ISO/IEC 14496-10); M-JPEG; H.265/HEVC
Streaming	Multiple configurable streams in H.265; H.264 and M-JPEG; Configurable framerate and bandwidth; Bosch Intelligent Streaming
Camera processing latency	<120ms
GOP structure	IP
Frame rate (fps)	1 fps – 30 fps

Video signal-to-noise ratio (dB)	>55 dB
Video resolution (H x V)	HD 1080p (16:9), 1920 x 1080 to 0.1MP (16:9), 512 x 288

Video content analysis

Analysis type	Intelligent Video Analytics Pro: IVA Pro Buildings
Alarm triggers	Any object; Object in field; Line crossing; Enter / leave field; Loitering; Follow route; Counting; Occupancy; Condition change; Similarity search; Objects stopping or starting to move
Object classes	Person; Vehicle
Object filters	Duration; Size; Aspect ratio; Direction; Color
Tracking modes	Base tracking (2D)
Number of possible alarm rules (simultaneously)	16
Additional functionalities	Tamper detection

Inputs and outputs

Ethernet	Shielded RJ45
----------	---------------

Storage

Internal storage	5-s-pre-alarm-recording
Memory card slot	Micro SDHC; Micro SDXC (a memory card of Class 6 or higher is recommended for HD recording)
Memory card capacity (GB)	32 GB for Micro SDHC; 2 TB for Micro SDXC card
Industrial SD cards	Extreme lifetime and health monitoring support that provides early service indication

Data security

PKI	X.509 certificates
End-to-end encryption	Full end-to-end with supported VMS
Encryption	TLS 1.2; AES 256; AES 128; TLS 1.3
Local storage encryption	XTS-AES

Video authentication	MD5; SHA-1; SHA-256; Checksum
----------------------	-------------------------------

Platform

Common Product Platform	CPP14.3
-------------------------	---------

Network

Ethernet type	10/100BASE-T
---------------	--------------

System integration

Protocols / standards	IPv4; IPv6; UDP; TCP; HTTP; HTTPS; RTP/RTCP; IGMP V2/V3; ICMP; ICMPv6; RTSP; FTP; ARP; DHCP; APIPA (Auto-IP, link local address); NTP (SNTP); SNMP (V1, MIBII); SNMP (V3, MIBII); DNS; DNSv6; DDNS (DynDNS.org, selfHOST.de, no-ip.com); SMTP; iSCSI; UPnP (SSDP); DiffServ (QoS); LLDP; SOAP; CHAP; Digest authentication
Conformity	ONVIF Profile S; ONVIF Profile G; ONVIF Profile T; ONVIF Profile M

Mechanical

Pan range (°)	0° - 355°
Tilt range (°)	0° - 75°
Roll range (°)	0° - 355°
Dimensions (Ø x H) (mm)	110 mm x 66 mm
Dimensions (Ø x H) (in)	4.33 in x 2.6 in
Weight (g)	230 g
Weight (lb)	0.51 lb
Color	White
Color in RAL	RAL 9003 Signal white
Bubble material	Clear polycarbonate
Coating type	Clear with anti-scratch coating
Material	Polycarbonate housing
Mounting type	Surface-mounted

Environmental

Operating temperature (°C)	0 °C - 40 °C
----------------------------	--------------

Operating temperature (°F)	32°F – 104°F
Storage temperature (°C)	-30°C – 70°C
Storage temperature (°F)	-22°F – 158°F
Operating relative humidity, non-condensing (%)	5% – 93%
Operating relative humidity, condensing (%)	5% – 100%
Storage relative humidity (%)	5% – 95%
Impact protection	IK08
Sustainability	PVC free
Country of origin	Thailand

Ordering information

NUV-3703-F02 Micro dome 5MP HDR 131°

Fixed dome camera for indoor 30 fps surveillance with H.264/H.265 and IVA Pro Buildings, 5MP, 131° lens, IK08, NDAA compliant
Order number **NUV-3703-F02**

Accessories

NDA-5081-PIP Pendant interface plate, 110mm

Pendant interface plate for the FLEXIDOME micro 3100i indoor and the FLEXIDOME panoramic 5100i families
Order number **NDA-5081-PIP**

NDA-5081-PLEN In-ceiling plenum rated kit, 110mm

Plenum-rated in-ceiling mount kit for FLEXIDOME panoramic 5100i and FLEXIDOME micro 3100i
Order number **NDA-5081-PLEN**

NDA-5080-CMB Corner mount box 45°, 110mm

Corner mount box for FLEXIDOME panoramic 5100i indoor and FLEXIDOME micro 3100i, 45° tilt angle
Order number **NDA-5080-CMB**

NDA-3081-4S 4S adapter plate, 171mm

4S adapter plate for FLEXIDOME micro 3100i indoor
Order number **NDA-3081-4S**

NDA-U-WMT Pendant wall mount

Universal wall mount for dome cameras, white
Order number **NDA-U-WMT**

NDA-U-PMT Pendant pipe mount, 12" (31cm)

Universal pipe mount for dome cameras, 31 cm, white
Order number **NDA-U-PMT**

NDA-U-PMTE Pendant pipe extension, 20" (50cm)

Extension for universal pipe mount, 50 cm, white
Order number **NDA-U-PMTE**

NDA-U-PSMB Pendant wall/ceiling mount SMB

Surface mount box (SMB) for wall mount or pipe mount.
Order number **NDA-U-PSMB**

NDA-U-WMP Wall mount plate

Back plate for universal wall mount, corner mount and pole mount, white, IP66
Order number **NDA-U-WMP**

NDA-U-PMAS Pole mount adapter small

Pole mount adapter small
Universal pole mount adapter, white; small.
Order number **NDA-U-PMAS**

NDA-5081-TM Tilt mount 20°, 110mm

Tilt mount (20°) for FLEXIDOME panoramic 5100i indoor and FLEXIDOME micro 3100i indoor
Order number **NDA-5081-TM**

NPD-5001-POE Midspan, 15W, single port, AC in

Power-over-Ethernet midspan injector for use with PoE enabled cameras; 15.4 W, 1-port
Weight: 200 g (0.44 lb)
Order number **NPD-5001-POE**

NPD-5004-POE Midspan, 4 port x 15W, AC in

Power-over-Ethernet midspan injector for use with PoE enabled cameras; 15.4 W, 4-ports
Weight: 620 g (1.4 lb)
Order number **NPD-5004-POE**

NDA-U-WMTG Pendant wall mount, gang box

Universal wall mount, compatible with gang box installation for fixed dome cameras only, white
Order number **NDA-U-WMTG**

NDA-U-PMTS Pendant pipe mount, 4" (11 cm)

Universal pendant pipe mount for dome cameras, 11 cm (4"), white
Order number **NDA-U-PMTS**

NDA-U-PMTG Pendant pipe mount, gang box

Universal pipe mount, compatible with gang box installation for fixed dome cameras only, white
Order number **NDA-U-PMTG**

Represented by:

Europe, Middle East, Africa:
Bosch Security Systems B.V.
P.O. Box 80002
5600 JB Eindhoven, The Netherlands
Phone: +31 40 2577 284
www.boschsecurity.com/xc/en/contact/
www.boschsecurity.com

Germany:
Bosch Sicherheitssysteme GmbH
Robert-Bosch-Ring 5
85630 Grasbrunn
Tel.: +49 (0)89 6290 0
Fax: +49 (0)89 6290 1020
de.securitysystems@bosch.com
www.boschsecurity.com

North America:
Bosch Security Systems, LLC
130 Perinton Parkway
Fairport, New York, 14450, USA
Phone: +1 800 289 0096
Fax: +1 585 223 9180
onlinehelp@us.bosch.com
www.boschsecurity.com

Asia-Pacific:
Robert Bosch (SEA) Pte Ltd, Security Systems
11 Bishan Street 21
Singapore 573943
Phone: +65 6571 2808
Fax: +65 6571 2699
www.boschsecurity.com/xc/en/contact/
www.boschsecurity.com